

CAD FILE:

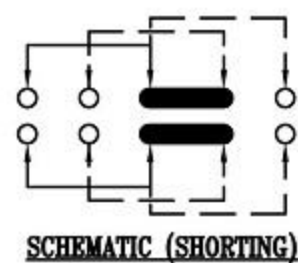
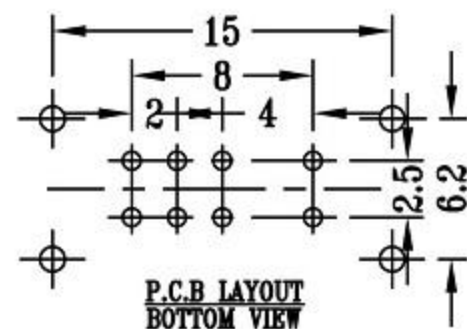
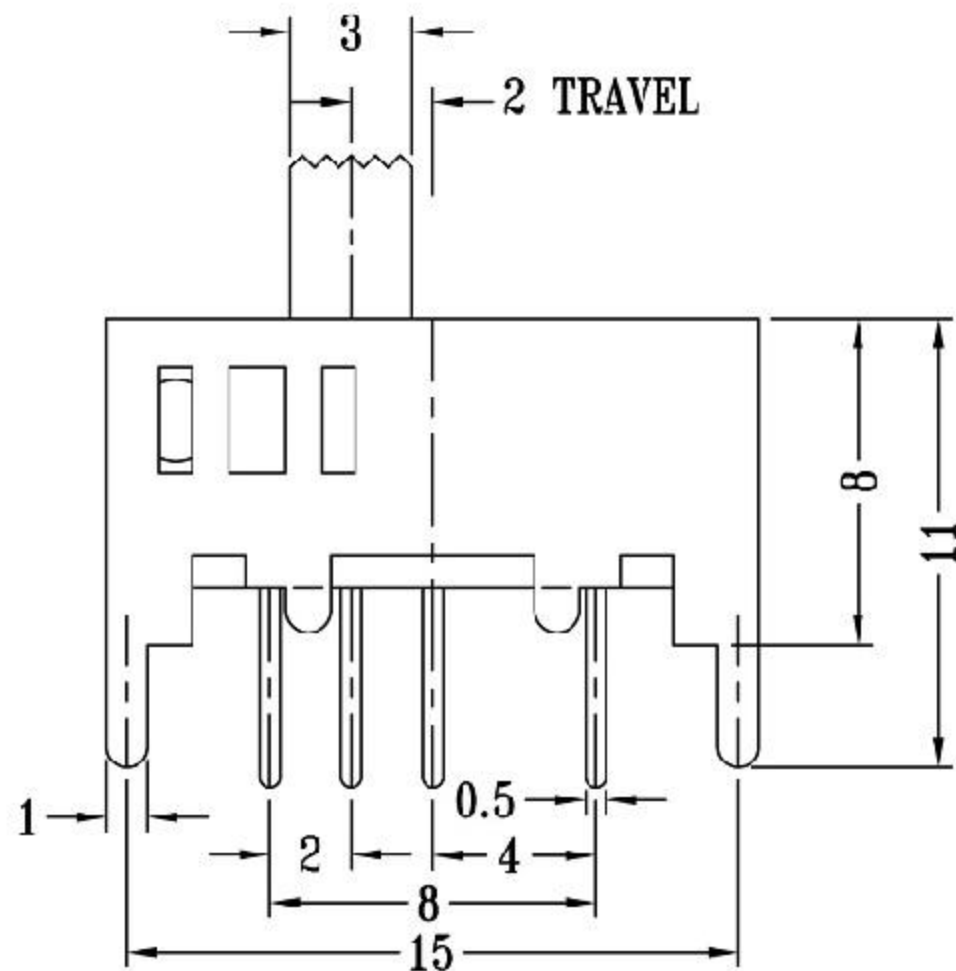
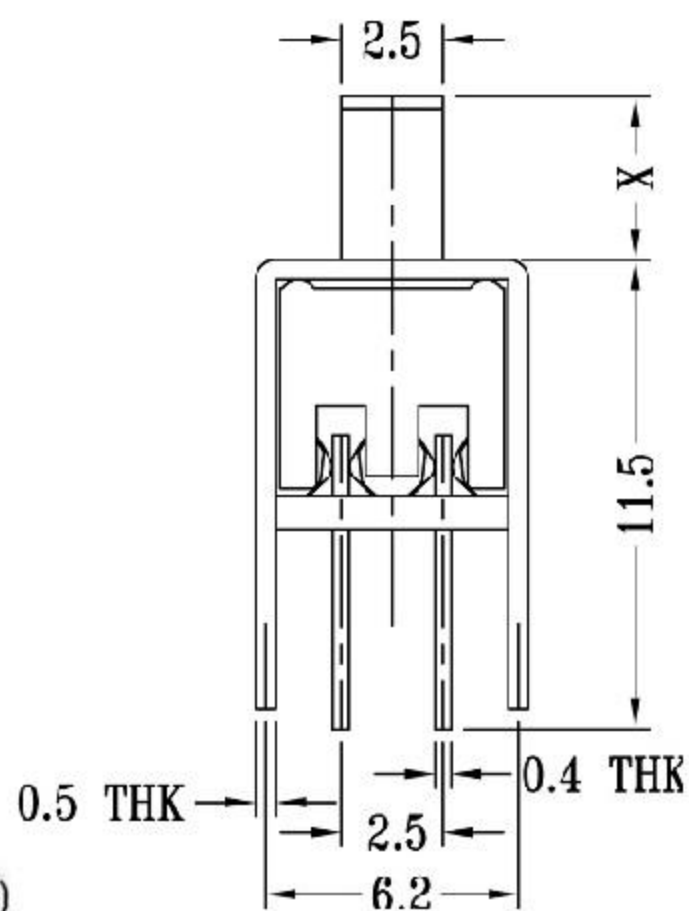
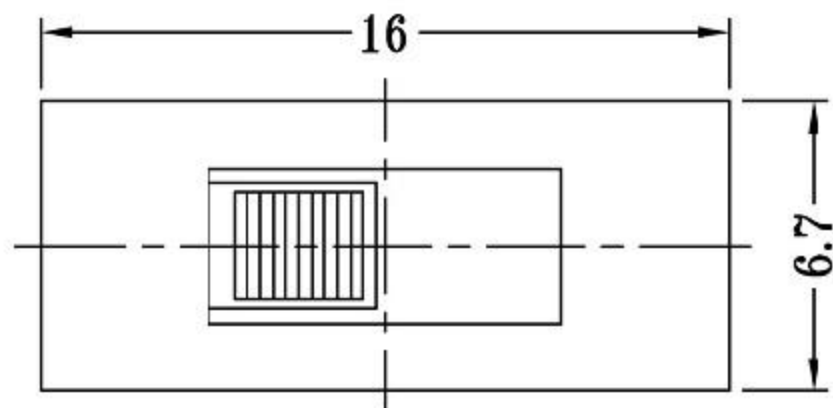

拨动开关立式技术参数:

1. 额定负荷: DC 30V 50V 0.3A 0.5A
2. 接触阻抗:  $\leq 50m\Omega$
3. 绝缘阻抗:  $\geq 100m\Omega$  DC500V
4. 耐焊温度:  $250 \pm 5^\circ$  5s
5. 使用寿命: 10,000 cycles
6. 使用温度:  $-25^\circ\text{C}$  to  $80^\circ\text{C}$
7. 使用湿度:  $\leq 85\%$  RH
8. 操作力: 160gf 256gf 300gf 可定制
9. 手柄长度: 2mm-10mm 可定制

注: "\*"表示关键尺寸(6个)

NO.	PARTS	MATERIALS	Q'TY	FINISH	TOLERANCE UNLESS SPECIFIED		DESCRIPTIONS OF REVISION		APPD.			
8					WITHIN	A	2012-10-28	初版				
7	STEEL BALL	STEEL	1	NATURAL	OVER	ISSUE	DATE					
6	SPRING	STEEL WIRE	1	NATURAL	TITLE : VERTICAL SLIDE SWITCH							
5	CONTACT CLIP	PBS STRIP	2	Ag PLATED	MODEL:		UNIT : mm	DRWG NO.:				
4	TERMINAL	BRASS STRIP	8	Ag PLATED			SCALE: 3:1	DWN.	2012-10-28			
3	BASE	PHENOLIC RESIN	1	NATURAL	<b>东莞市高迪电子有限公司</b>					CHK'D		
2	FRAME	STEEL STRIP	1	Ni PLATED						APPD.		2012-10-28
1	KNOB	POM	1	BLACK								